

# **MIPRO**<sup>®</sup>

MICROPHONE PROFESSIONALS

ACT-800T UHF Digital

ACT-700T/ACT-500T UHF Analog

ACT-580TR 5.8 GHz Digital Recordable

ACT-580T/5.8 GHz, ACT-240T/2.4 GHz Digital

Bodypack Transmitters    User Guide



# I. Parts Name

## ACT-800T/ACT-700T

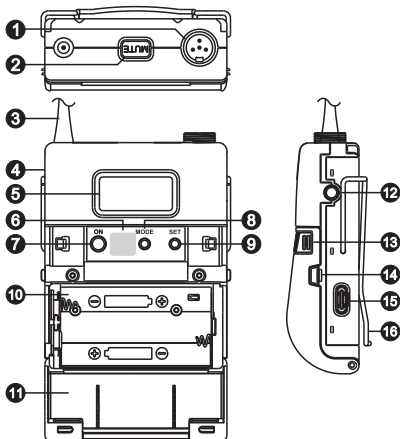

## ACT-580T/ACT-240T

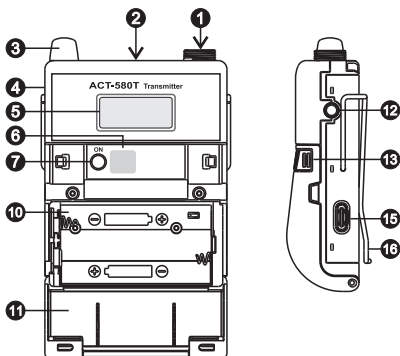

1

ACT-500T/ACT-580TR

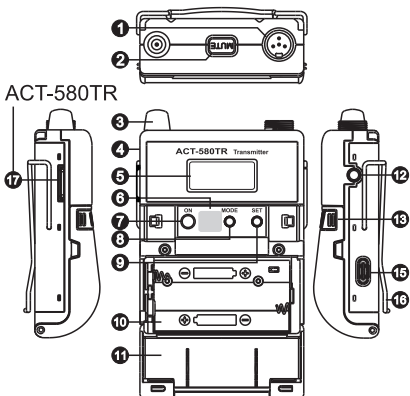

- ❶ 4-Pin Microphone Input Jack
- ❷ Mute Button
- ❸ Transmitting Antenna  
(varies by different model)
- ❹ Housing
- ❺ LCD Panel
- ❻ ACT Sync Window
- ❼ Power button
- ❽ MODE button (ACT-800T/ACT-700T/  
ACT-500T/ACT-580TR)
- ❾ SET Button (ACT-800T/ACT-700T/  
ACT-500T/ACT-580TR)

- ⑩ Battery Holder
- ⑪ Battery Cover
- ⑫ Remote Control Mute Connector
- ⑬ Battery Cover Hooks
- ⑭ Battery Charging Contacts  
(ACT-800T/ACT-700T )
- ⑮ USB Type-C Charging Port and  
Charging Indicator
- ⑯ Belt Clip
- ⑰ SD Card Slot (ACT-580TR)

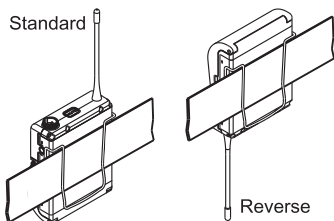

## II. 4-Pin Microphone Input Jack Connection

1. Before powering on, connect the input signal source to the microphone input jack ❶ first to avoid open-circuit-induced noise.
2. Align and fasten the connector clockwise for a secured fit.

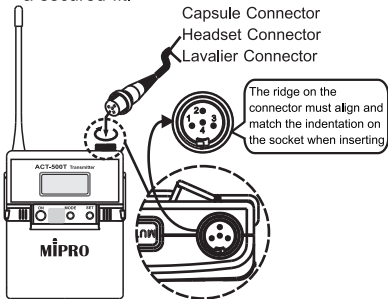

## III. Battery Insertion and Replacement

1. Battery Insertion:
  - (A) Press the battery cover side hooks ❸ inward to lift the battery cover.
  - (B) Insert one 18500 lithium battery or two AA batteries.
  - (C) 18500 lithium battery insertion: positive (+) faces toward left.
  - (D) AA batteries insertion: insert one into the lower holder with positive (+) toward left, and then insert another into the upper holder with negative (-) toward left.
2. Check battery polarity or capacity if unable to turn on the transmitter.
3. Power off to conserve battery power. Remove the battery when it will not be used for an extended period of time.

## Bodypack Transmitters

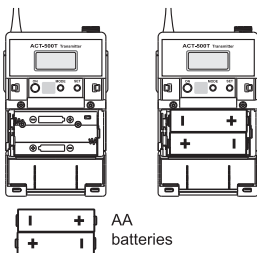
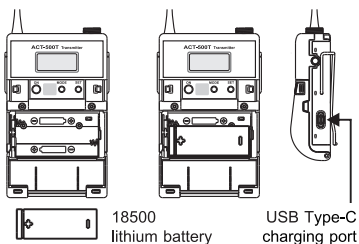
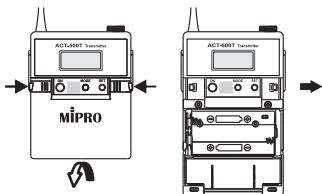

4. This device only accepts an ICR-18500 lithium battery. Charging notice:
- (A) Before charging, make sure the inside battery is an ICR-18500 lithium battery.
  - (B) Confirm the battery polarity is inserted correctly.
  - (C) Turn off the power before charging.
  - (D) **DO NOT** charge AA batteries or NiMH batteries. Any damage caused by using incorrect batteries is excluded from the warranty.
  - (E) The charging port doesn't supply the power for the device.
  - (F) Do not remove the lithium battery during charging status. Detach the charging cable before removing the lithium battery.
  - (G) Check the 18500 lithium battery is inserted correctly if the indicator doesn't glow.
5. Charging by USB Type C, shown as figure left. Indicator: Red (charging); Green (full)



6. Charging ACT-800T/ACT-700T by an optional charging station, shown as figure right.

- (A) Connect the power and make sure the indicator lights up.
- (B) Indicator: Red (charging); Green (full)

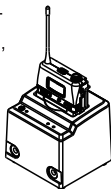

## IV. Operating Instructions

### 1. Power On/Off:

(A) Press and hold Power button to turn on and turn off. The LCD panel glows when power is on.

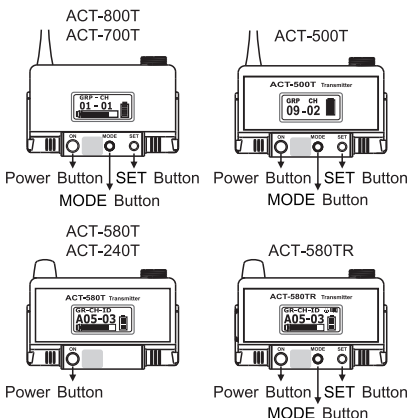

(B) The LCD shows OFF... during turn-off.



2. Press MODE button to select functions.
3. Press SET button, and the parameter blinks, press SET button again to change the parameter.
4. Battery Level Status:

Replace with a charged battery once the level falls to 10%. The device will power off automatically with an OFF message once the power level falls too low.

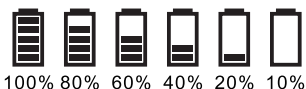



## V. LCD and Operating Instructions

### 1. LCD Display:

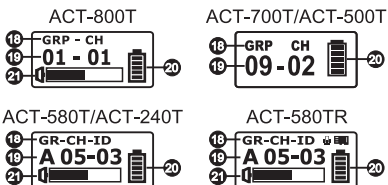

- 18 Functions
- 19 Parameters
- 20 Battery Status
- 21 Audio Signal Level Bar

### 2. ACT-800T LCD:

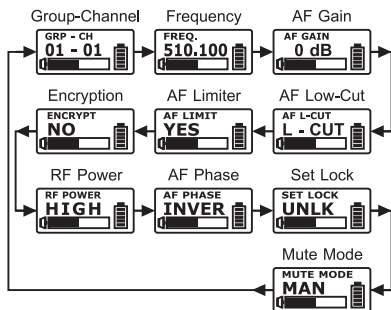

(A) GRP (Group) - CH (Channel) / FREQ. (Frequency):

- (1) Group / Channel / Frequency is synced from the receiver and cannot be changed.
- (2) To change Group / Channel / Frequency, do it at the receiver and then press ACT button to sync.



Group / Channel

Frequency

- (3) The specific group and channel set via PC will display  $\times \times \times - \times \times \times$ .



**(B) AF GAIN:**

- (1) AF Gain can be changed from -12dB ~ 18dB, in 6dB steps.
- (2) The higher the AF gain is, the lower the dynamic range for input signal will be and it will increase noise and feedback chances.
- (3) Set AF Gain to 0dB for electric guitar. The maximum input signal strength is  $2V_{RMS}$  (6dBV).

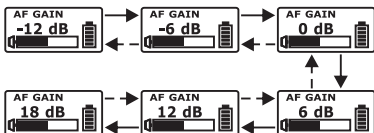

**(C) AF L-CUT:**

- (1) Select L-CUT or FLAT.
- (2) L-CUT: the frequency response at 100Hz will decrease about 3dB with a slope of -6dB/Octave.



**(D) AF LIMIT:**

- (1) Select YES or NO.
- (2) YES: the maximum output of the receiver is limited to 1V.



(E) ENCRYPTION: Display Encryption Information

The ENCRYPTION function must be set at the receiver first then using ACT to program the transmitter. (Refer to ENCRYPTION function of the receiver)



(F) RF POWER:

Select HIGH or LOW.



(G) AF PHASE:

- (1) Select NORM or INVER. NORM is positive polarity; INVER is reverse polarity.
- (2) AF PHASE function provides users a phase selection for different condenser microphones. The normal setting is NORM, and INVER might be selected if a two-wire condenser microphone is used.



(H) SET LOCK:

- (1) Select UNLK or LOCK.
- (2) Under LOCK mode, settings cannot be changed including power on / off. To power off, it must be under unlock mode (UNLK). A sudden loss of power will disable LOCK.
- (3) MUTE function can be operated normally under LOCK mode.

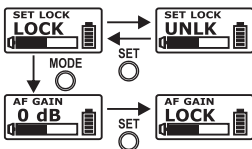

(H)MUTE MODE:

(1) Select MAN, HOLD, or. DIS.



(2) MAN (Manual): the mute function is controlled by MUTE button.

(a) Press MUTE button to mute the transmitter, and the Audio Signal Level Bar ② shows AF MUTE and blinks. Press again to unmute and the blink stops.

(b) AF MUTE will be disabled automatically when power is off.

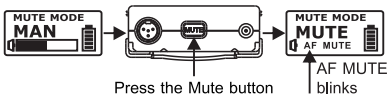

(3) HOLD:

(a) Under HOLD mode, press Mute button to mute, and release it to unmute.

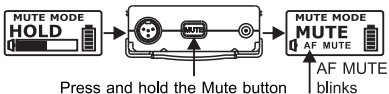

(b) Under HOLD mode, use ON/OFF of Remote Mute Switch to mute/unmute.

MUTE ON  
audio is muted.

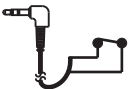

MUTE OFF  
audio is on.

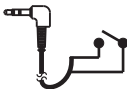

(4) DIS: Disable the mute function.

(5) Under mute status, MODE and SET buttons are operational.



(J) Error codes:

- (1) ROM-ER → Channel wasn't programmed or internal data error.
- (2) ERROR1 → RF frequency targeting circuitry is failed.
- (3) NO---03 → the set frequency exceeds the upper band. The transmitter frequency will not be changed but it can be operated as long as the power switch is turned on again.
- (4) NO---04 → The set frequency exceeds the lower band. The transmitter frequency will not be changed but it can be operated as long as the power switch is turned on again.

### 3. ACT-700T / ACT-500T LCD:

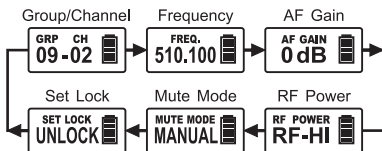

(A) GRP (Group) /CH (Channel) /FREQ. (Frequency):

- (1) Group / Channel / Frequency messages are displayed only and cannot be changed.
- (2) To change Group / Channel / Frequency, do it at the receiver and then press ACT button to sync.

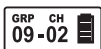

Group / Channel



Frequency

- (3) For those specific channels set via PC, the screen shows only CHANNEL and numbers.



(B) AF Gain:

- (1) AF Gain can be changed from 12dB ~ -12dB, in 6dB steps.
- (2) The higher the AF Gain is, the lower the input signal of dynamic range will be and it will increase noise and feedback chances.
- (3) Set AF Gain to -12dB for electric guitar.
- (4) 0dB is the factory default setting.



(C) RF POWER: Select RF-HI or RF-LOW.



(D) MUTE MODE:

- (1) Select MANUAL or DISABLE.
- (2) MANUAL: Use MUTE button to mute/unmute.
- (3) DISABLE: MUTE button is disabled. Mute setting is canceled.



(E) SET LOCK:

- (1) Select LOCK or UNLOCK.
- (2) Under LOCK mode, settings cannot be changed including power on / off. To power off, it must be under unlock mode (UNLK). A sudden loss of power will disable LOCK.
- (3) MUTE function can be operated normally under LOCK mode.

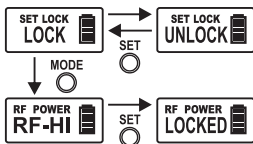

(F) Error Codes:

- (1) ERR no01 → EEPROM Channel wasn't programmed or internal data error.
- (2) ERR no02 → for testing only.
- (3) ERR no03 → the set frequency exceeds the upper band. The transmitter frequency will not be changed but it can be operated as long as the power switch is turned on again.
- (4) ERR no04 → the set frequency exceeds the lower band. The transmitter frequency will not be changed but it can be operated as long as the power switch is turned on again.

(G) GROUP CHANNEL: The preset frequency of the receiver.

(H) Displays "CHANNEL" only: User-defined frequency of receiver and needs to be changed via PC.

(I) MUTE Button:

- (1) MUTE button is only workable under MANUAL mode. Press MUTE button to enter mute status.
- (2) Press MODE and SET buttons to select parameters. Idle for 5 seconds and return to MUTE mode.
- (3) Press MUTE button again to unmute.
- (4) Unmute Mode: The screen shows UNMUTE for 1 second and returns to Home Screen.

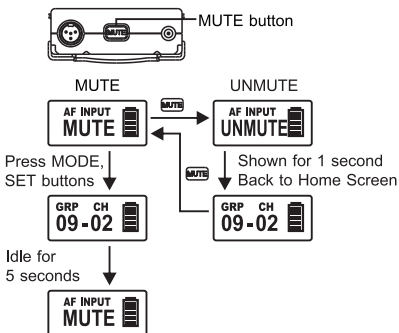

4. ACT-580T / ACT-240T LCD:

(A) GR (Group) – CH (Channel) – ID (ID Code):

- (1) Group / Channel / ID Code messages are displayed only and cannot be changed.
- (2) To change Group / Channel / ID Code, do it at the receiver and then press ACT button to sync.

Group-Channel-ID Code



- (3) ACT-240T: GROUP A, CH 1~12, ID 1~64.  
 ACT-580T: GROUP A, B1, B2, CH 1~12, ID 1~64, and **P** pairing mode.



**(B) MUTE Button:**

- (1) Press the MUTE button to enter mute status. LCD shows MUTE, and the ACT function still can be activated.
- (2) Press again to unmute. The mute setting will be canceled automatically when power is off.

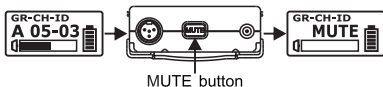

- (3) Lock: Power off. Press and hold the MUTE button, and power on to disable the MUTE button. LCD shows DISABLE.

Lock the MUTE button:

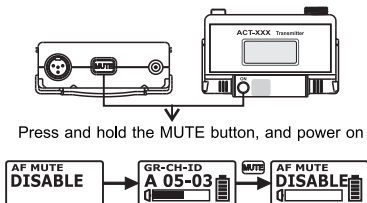

- (4) Disable Lock: Power off. Press and hold the MUTE button, and power on to enable the MUTE button. LCD shows ENABLE.

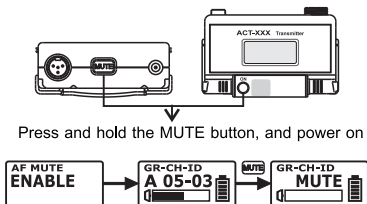

5. ACT-580TR SD Memory Card:

- (A) Purchase a high-speed Micro SDHC card.
- (B) Format the card in FAT 32. The system may stop recording when the capacity is less than 250M. Formatting is required if there's no capacity.
- (C) Power off before pushing in the SD card.
- (D) Push the SD card into the slot with the sticker facing down.
- (E) Push it again to remove the SD card.
- (F) The recording format is .wav, mono 24bit – 144 kbytes/s.

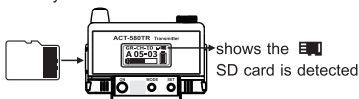

6. ACT-580TR LCD:

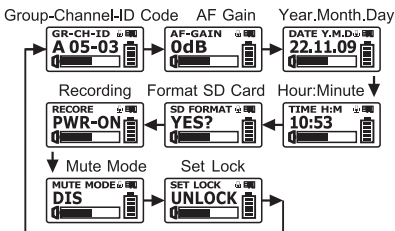

(A) GR (Group) – CH (Channel) – ID (ID Code):

- (1) Group / Channel / ID Code messages are displayed only and cannot be changed.
- (2) To change Group / Channel / ID Code, do it at the receiver and then press ACT button to sync.
- (3) Group settings: A, B1, B2; CH setting: 1-12; ID setting: 1-64 and Pairing mode:

Group-Channel-ID Code



(B) AF GAIN:

- (1) AF Gain can be changed from 0dB ~ 36dB, in 6dB steps. 18~24 dB is recommended for using general microphones to pick up.
- (2) If the AF Gain is set higher, a high input signal will cause distortion and noise floor. When other speakers are working at the same time, it will increase feedback chances.
- (3) Set AF Gain to 0dB for electric guitar.
- (4) 0dB is the factory default setting.

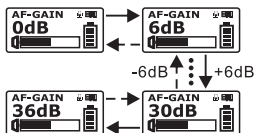

(C) Year.Month.Day:



(D) Hour:Minute:



(E) Format SD Card:

- (1) YES?: Format or not? (2) YES...: Formatting



(F) Recording:

- (1) PWR-ON: "PWR-ON" indicates it's recording now.
- (2) STOP: "STOP" disappears to indicate stop recording.



(G) MUTE MODE: DIS (Disable) / MAN (Manual)

- (1) Disable Mode: The mute button is unfunctional and unmute.



- (2) Manual Mode: Use the mute button to mute/unmute.
  - (a) Press MUTE button to enter mute status. The Audio Signal Level Bar 21 shows AF MUTE and blinks. Press MUTE button again to unmute.
  - (b) AF MUTE will be disabled when power is off.
  - (c) The recording function is not affected by the mute button.

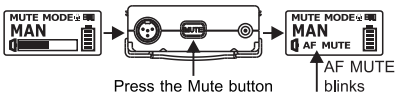

(H)SET LOCK:

- (1) Select LOCK or UNLOCK.
- (2) Under LOCK mode, settings cannot be changed including power on / off. To power off, it must be under unlock mode (UNLK). A sudden loss of power will disable LOCK.
- (3) MUTE function can be operated normally under LOCK mode.

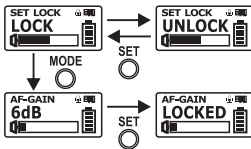

## VI. Other Operations

1. Remote Control Mute Connector:  
3.5 Ø Remote Control Mute Connector is for accepting MJ-70 Remote Mute Switch Cable.
2. Remote Mute Switch (Optional): Plug MJ-70 Remote Mute Switch into Remote Control Mute Connector  before powering on.

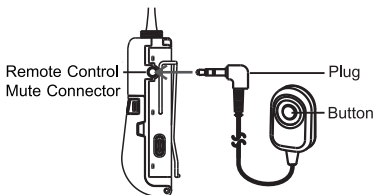

## VII. High-frequency Noise Interference

High-frequency noise interference produces continuous high-frequency noise, which deteriorates sound quality. All MIPRO microphone capsule modules have a high-frequency noise interference prevention design. High-frequency noise interference may occur when other brands' microphone capsules are plugged into MIPRO transmitters.

## VIII. Notes

1. Refer to the actual product in the event of product description discrepancy.
2. The frequency range and maximum deviation comply with the regulations of different countries.
3. Spraying alcohol directly onto the condenser capsule module will cause severe damage and invalidate the warranty.

## IX. 4-Pin Microphone Input Jack Wiring

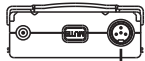

1. 2-wire electret condenser microphone capsule connection.

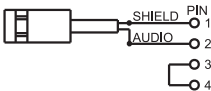

2. 3-wire electret condenser microphone capsule connection.

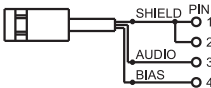

3. Dynamic Microphone.

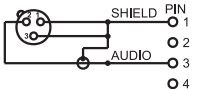

4. Electric Guitar.

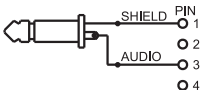

5. Line-in (impedance 8K ATT 10dB).

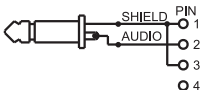

## Bodypack Transmitters

---

### Federal Communication Commission Interference Statement

This equipment has been tested and found to comply with the limits for a Class B digital device, pursuant to Part 15 of the FCC Rules. These limits are designed to provide reasonable protection against harmful interference in a residential installation.

This equipment generates, uses and can radiate radio frequency energy and, if not installed and used in accordance with the instructions, may cause harmful interference to radio communications. However, there is no guarantee that interference will not occur in a particular installation. If this equipment does cause harmful interference to radio or television reception, which can be determined by turning the equipment off and on, the user is encouraged to try to correct the interference by one of the following measures:

- . Reorient or relocate the receiving antenna.
- . Increase the separation between the equipment and receiver.
- . Connect the equipment into an outlet on a circuit different from that to which the receiver is connected.
- . Consult the dealer or an experienced radio/TV technician for help.

FCC Caution: To assure continued compliance, any changes or modifications not expressly approved by the party responsible for compliance could void the user's authority to operate this equipment. (Example - use only shielded interface cables when connecting to computer or peripheral devices).

### FCC Radiation Exposure Statement

This equipment complies with FCC RF radiation exposure limits set forth for an uncontrolled environment. This equipment should be installed and operated with a minimum distance of 0.5 centimeters between the radiator and your body.

This transmitter must not be co-located or operating in conjunction with any other antenna or transmitter.

The antennas used for this transmitter must be installed to provide a separation distance of at least 0.5 cm from all persons and must not be co-located or operating in conjunction with any other antenna or transmitter.

This device complies with Part 15 of the FCC Rules. Operation is subject to the following two conditions:

- (1) This device may not cause harmful interference, and
- (2) This device must accept any interference received, including interference that may cause undesired operation.

ACT-800T/ACT-700T/ACT-500T frequency  
range:

NCC : 510~530MHz / 748~758MHz

FCC : 470~608MHz

CE : 470~789MHz / 823~832MHz

**MIPRO**<sup>®</sup>  
MICROPHONE PROFESSIONALS



**MIPRO Electronics Co., Ltd**

Headquarters: No. 814, Beigang Rd., Chiayi City 600079, Taiwan

Tel : +886.5.238.0809

Fax : +886.5.238.0803

[www.mipro.com.tw](http://www.mipro.com.tw)

[mipro@mipro.com.tw](mailto:mipro@mipro.com.tw)

All rights reserved. Do not copy or forward without  
prior approvals of MIPRO. Specifications and design  
subject to change without notice. YM 022/10



2 CE683A